

**printstuff.ca**  
BIG OR SMALL, WE PRINT IT ALL.



TRADESHOW SOLUTIONS

# TRUE VERSATILE PORTABLE DISPLAY CATALOG

## TABLE OF CONTENT

- 4-7 **X BANNER STANDS**  
MDI, NT, NP
- 8-9 **Y BANNER STANDS**  
Neos Indoor, Neos Outdoor-F
- 10-13 **VERSATILE STANDS**  
Tech One, Tech Ten, I Banner, I Banner XL
- 14-19 **ROLL UP BANNER STANDS**  
Eco, Eco 24, Fair, Clone, Swap II, Nubi,  
Swap V36, Swap V48, Swap V60
- 20-21 **FABRIC POP UP SYSTEMS**  
Counter stand, Table top, Wall Systems  
(Straight/Curve)
- 22-31 **TENSION FABRIC SYSTEMS**  
Wall Systems (Flat/Horizontal Curve/S Shape),  
Stretch Podium Hard Case, Fusion Booth,  
Podium/Rack, Brand+ Fitting Room, Tablet Stand,  
Easy-Tube, BAAM, PYLON, LUNAR, COLUMN, ARC,  
ARCH Displays, Hanging Banners
- 32-33 **TABLE THROWS & COVERS  
/ TABLE TOP BANNER**  
Non-fitted, Fitted, Stretch, Table Topper, Convertible,  
Cross Over, Table Runner, Cocktail Table Cover,  
Table Top Banner
- 34 **OUTDOOR DISPLAYS**  
Snap Frame Poster Stand, AD Base,  
Literature Stand
- 35 **POP OUT DISPLAYS**  
Horizontal, Vertical, Round, Tower
- 36-38 **FLAG BANNER SYSTEMS**  
Teardrop Flags, Feather Flags, Dura Flags  
Boost Flags (Sailor/Top)
- 39 **TABLETOP & CEILING DISPLAYS**  
Mini Roll-up, Ceiling Poster Hanger  
T-Table Top, Mini X
- 40-41 **CANOPY SYSTEMS**  
10', 15', 20'
- 42 **GRANDE FRAMELESS FABRIC  
DISPLAYS**  
4' x 8', 8' x 8', 16' x 8'

# X Banner Stands

Our state of the art quality X banner stands are available in various kinds and options for sizing. Sleek and luxurious look that is truly eye-catching for displaying graphics during sales presentations, special events, trade shows, product promotion or in retail environments. It is lightweight and sets-up in less than a minute. Adjustable mechanism allow for hanging multiples of different screen sizes on one single stand. Water tank option available for temporarily outdoor usage. Ideal for frequently changing graphics.



## OPTIONS



### X WATER TANK

- Great solution for outdoor use or at high traffic zone
- Hallow molded base tank can be filled with water or sand
- Water capacity: 30LB (13.5KG)

\* X Water tank can be used with MDI 101, NT 101



### X TUBE BAG

- Great solution for travel
- Hold up to 2 x banner stands and banners
- Available in two sizes (D: 5" x L: 40" or 54")

# MDI SERIES

## Deluxe Premium X Banner Stands

- Sleek & Luxurious Design
- Compact Packaging
- Extra Fine Chrome Body Finishing
- Adjustable Width & Angle
- Superb Duralumin Construction
- Adjustable Lower Hooks

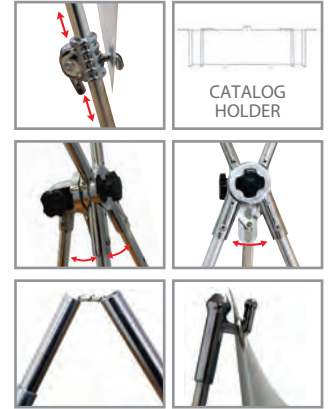





# NT SERIES

## Premium X Banner Stands

- Excellent Durability with FRP + Steel
- Adjustable Tension Strength
- Extra Height Extension Pole Available
- Adjustable Lower Hooks
- Shock Corded Poles
- Adjustable Width and Angle

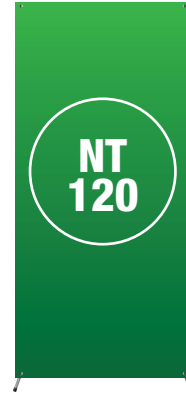

CARRYING BAG

## NT SERIES SIZE CHART

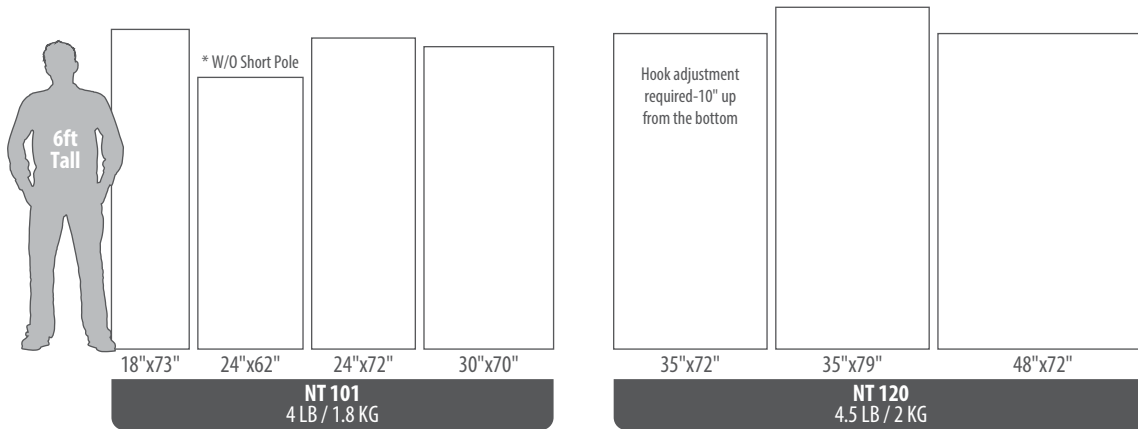

## OPTIONS



### X WATER TANK

- Great solution for outdoor use or at high traffic zone
- Hollow molded base tank can be filled with water or sand
- Water capacity: 30LB (13.5KG)

\* X Water tank can be used with MDI 101, NT 101



### X TUBE BAG

- Great solution for travel
- Hold up to 2 x banner stands and banners
- Available in two sizes (D: 5" x L: 40" or 54")



# NP SERIES

## Econ X Banner Stands

- Super Light Weight
- Rapid Deploy-Set Up in 10 seconds
- Ideal for Low Budget
- Volume Application
- Adjustable Lower Hooks



CARRYING BAG

## NP SERIES SIZE CHART

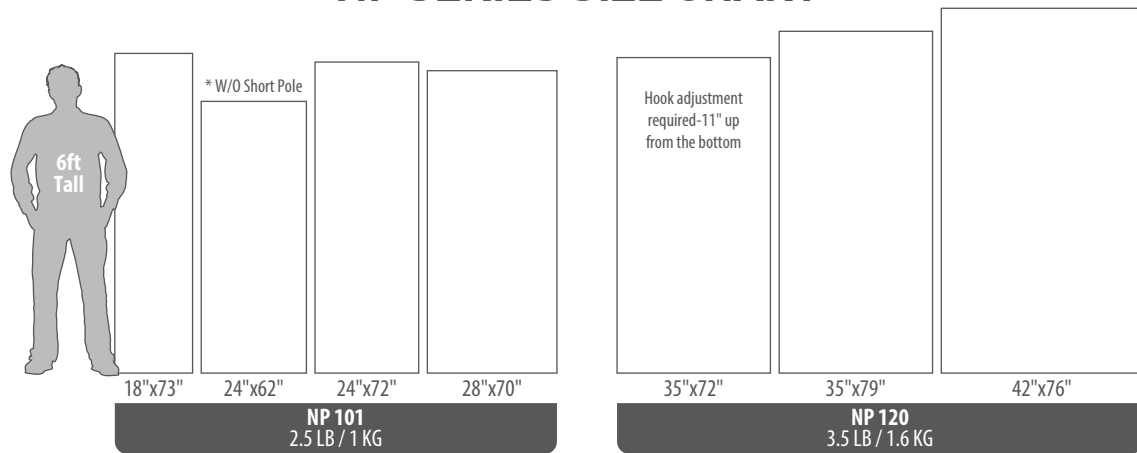

## OPTIONS



### X TUBE BAG

- Great solution for travel
- Hold up to 2 x banner stands and banners
- Available in two sizes (D: 5" x L: 40" or 54")

# Y Banner Stands

The Y banner stand is wonderfully effective and portable way to deliver a branded message at instant. Its versatility is unmatched as it can be used in single or double sided applications with adjustable width and height options. This unit is ideal for use in trade shows, lobbies, retail environments and other high traffic areas. Available for indoor and outdoor style. Supplied with carrying case. The printed banner is displayed with hooks at each corner anchoring your banner in place. The printed banner must have grommet eyelets at each corner allowing for simple print changes. Ideal for frequently changing graphics.



## NEOS INDOOR

### Dependable Indoor Solution!

- Use with Single or Double Sided banner
- Adjustable Width & Height
- Constructed to Hang Various Banner Sizes

<b>MATERIAL:</b> PC + FRP & Aluminum	<b>WEIGHT:</b> 11 LB ( 5 Kg )
<b>GRAPHIC SIZES:</b>	
W.24" x H.48"~100" ( 61cm x 122cm~254cm )	
W.35" x H.60"~96" ( 89cm x 153cm~244cm )	
W.48" x H.48"~90" ( 122cm x 122cm~229cm )	



CARRYING BAG



SIDE VIEW

FULLY ADJUSTABLE HEIGHT & WIDTH OF BANNER

**MULTI SIZE**

**SINGLE OR DOUBLE**



ELEVATION ADJUSTABLE



GET CREATIVE WITH SHAPE



TOP WIDTH ADJUSTABLE FEATURE



TELESCOPIC POLE



BOTTOM WIDTH ADJUSTABLE FEATURE



ELEVATION / TENSION ADJUSTABLE



# NEOS OUTDOOR-F

Fixed Type / Dependable Outdoor Solution!

- Use with Single or Double Sided banner
- Adjustable Width & Height
- Excellent Stability

**MATERIAL:**

PC + FRP & Aluminum

**WEIGHT:**

14 LB ( 6.4 Kg )

**GRAPHIC SIZES:**

W.18" x H.54" ~66" ( 46cm x 138cm ~167cm )

W.24" x H.50" ~60" ( 61cm x 128cm ~152cm )

W.30" x H.46" ~52" ( 76cm x 117cm ~132cm )

W.35" x H.37" ~48" ( 89cm x 94cm ~122cm )

**WATER CAPACITY:**

30LB (13.5KG)



CARRYING BAG



FRONT



DOUBLE SIDE



SINGLE SIDE



DOUBLE SIDE POLE POSITION



SINGLE SIDE POLE POSITION



# Versatile Stands

Versatile displays feature unique, attractive and portable way of displaying branded messages during sales presentations, special events, trade shows, or in retail environments. The Tech One features a rotating center hub which allows the banner to be displayed horizontally or vertically. With its telescoping pole, the height can be adjusted to accommodate various banner sizes. The Ibanner would be a perfect solution to be displayed in a limited space area. It can accommodate single or double sided banner and its unique design allows the banner to be displayed on the floor level or away from the floor level.

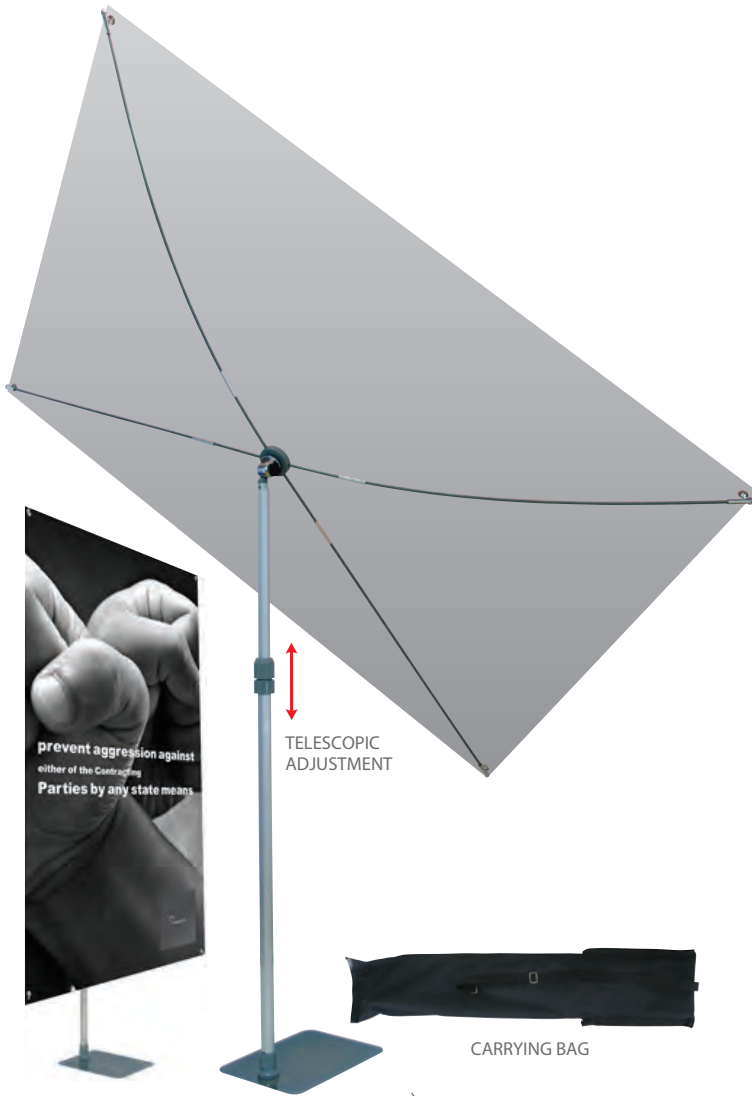

## TECH ONE



### Telescopic Versatile Banner Stands

- Vertical to Horizontal
- Telescopic Height & Tilt Function
- Selection of many banner sizes

**MATERIAL:**

PC + FRP & Aluminum

**WEIGHT:**

11 LB ( 5 Kg)

**GRAPHIC SIZES:**

24" x 82" ( 61cm x 208cm)

35" x 79" ( 89cm x 200cm)

48" x 48" ( 122cm x 122cm)\*

60" x 60" ( 153cm x 153cm)

35" x 62" ( 89cm x 158cm)\*

40" x 74" ( 102cm x 188cm)

48" x 72" ( 122cm x 183cm)

\* W/O Short Pole



ADJUSTABLE VIEWING ANGLE TILT FUNCTION

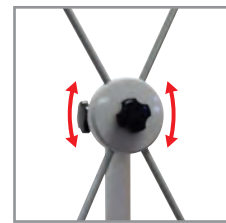

ALL ANGLE ROTATING FUNCTION

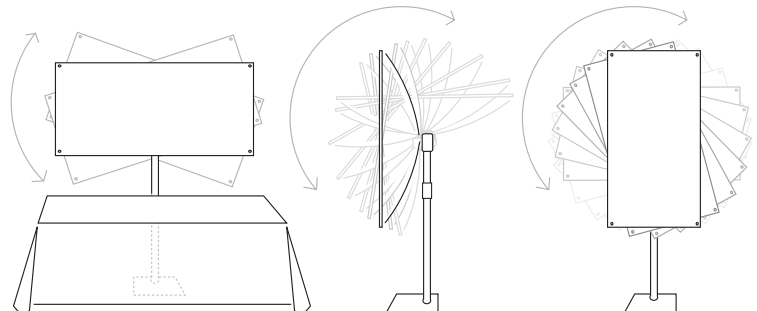
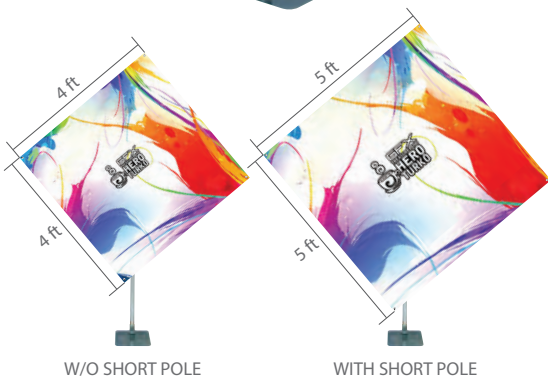



TELESCOPIC  
ADJUSTMENT  
UP TO 9 FT

# TECH TEN

TECH TEN brings you the true simplicity of the wall and backdrop built with highly durable and light weight aluminium pole. Fully adjustable of height with durable telescopic aluminum structure. ( From 7.5' up to 9' ) Simple pocket finishing.

**MATERIAL:**  
PC & Aluminum

**WEIGHT:**  
15.5 LB ( 7 Kg )

**GRAPHIC SIZES:**  
W.87" x H.90" ~108" (221cm x 229cm~274cm)  
W.110" x H.90" ~108" (280cm x 229cm~274cm)

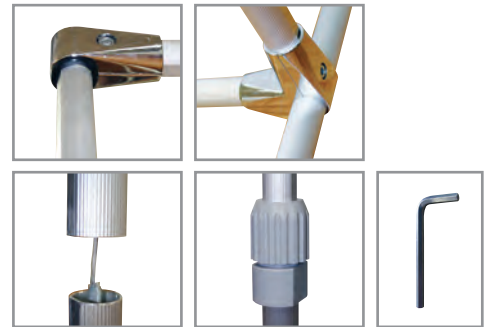

## TECH TEN STANDARD SIZE

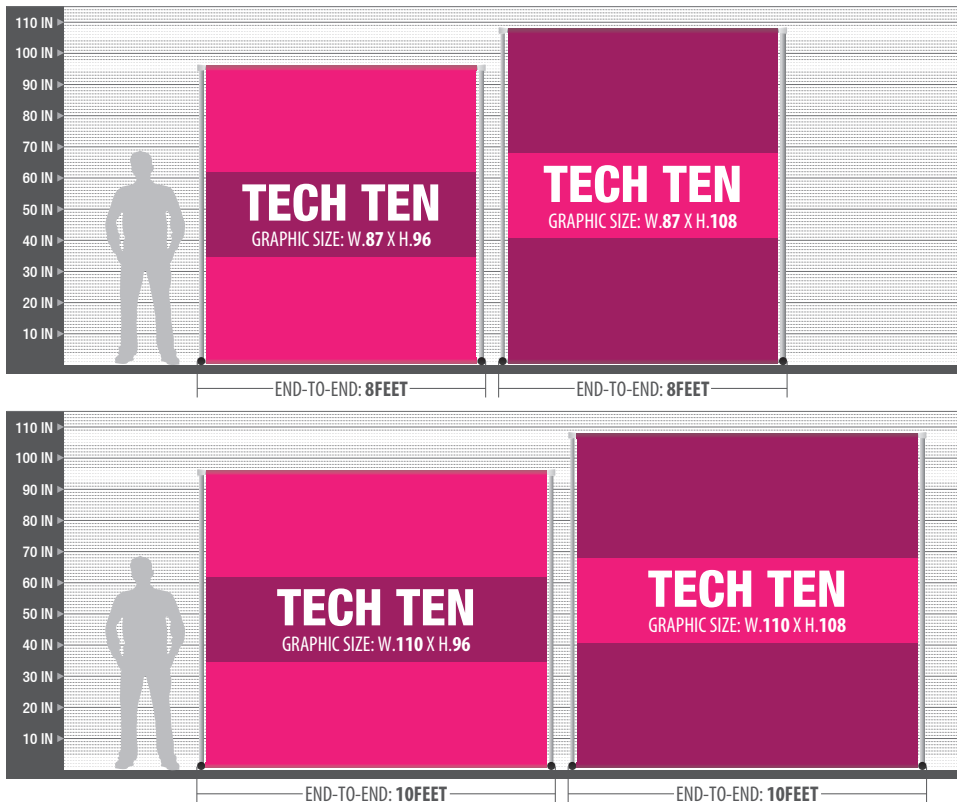



# I BANNER

## Telescopic Versatile Banner Stands

- Single or Double Banner
- On the floor level
- Away from the floor level
- Full Banner or Half Banner

**MATERIAL:** PC & Aluminum  
**WEIGHT:** 10 LB ( 4.5 Kg )

**GRAPHIC SIZES:**  
 H. 24"~90" ( 61cm~228cm )  
 W. 35.5" ( 90.17cm )

*\* Custom size available (Width)*

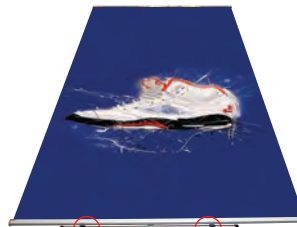

ATTACHABLE BASE CLIPS



CARRYING BAG

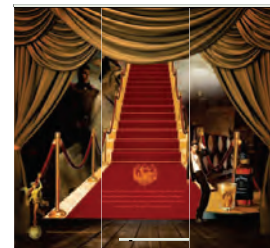
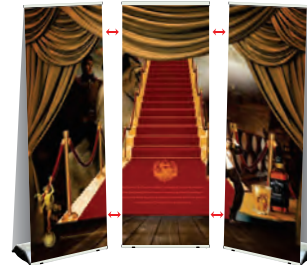





# I BANNER XL

**X-LARGE** Telescopic  
Versatile Banner Stands

- Single or Double Banner
- On the floor level
- Away from the floor level
- Full Banner or Half Banner

**MATERIAL:**  
PC & Aluminium

**WEIGHT:**  
11 LB ( 5.1 Kg )

**GRAPHIC SIZES:**  
H. 46"~120" ( 111cm~300cm )  
W. 47.5" ( 120cm )

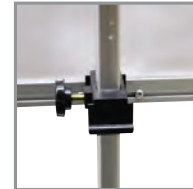

## I BANNER STANDARD SIZE



### OPTION

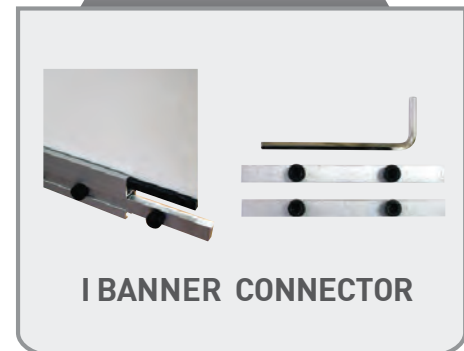



# Roll Up Banner Stands

Roll up banner stands allow for the creation and presentation of a visually explosive message, at an amazing value, along with minimal set-up time. In seconds, these units can be assembled and work promote your brand. The high impact customized graphic, rolls into the stand for protection, and when ready for take down, each unit folds down neatly, into its own carry bag. Optional light kit available.



CARRYING BAG

## ROLL-UP FAIR

- Cost Effective
- Volume Application
- Light Weight

**GRAPHIC SIZE:**  
33" x 78.75" ( 85cm x 200cm )  
**WEIGHT:**  
6.2 LB ( 2.8 Kg )



CARRYING BAG

## ROLL-UP CLONE

- Sleek & Luxurious Design
- Double Sided Banner
- Easy Set-up

**GRAPHIC SIZE:**  
33" x 78.75" ( 85cm x 200cm )  
**WEIGHT:**  
14.4 LB ( 6.6 Kg )



## OPTIONS



**CLAMP LIGHT**  
(Silver)

\* Not available for ROLL-UP CLONE



### CANVAS HARD BAG

Available in 40" & 52"

\* 40" - Inner dimension 39"x10"x3.5"

\* 52" - Inner dimension 51"x11"x3.5"



CARRYING BAG

## ROLL-UP ECO

- High Volume Application
- Low Pricing Point
- Light Weight
- Easy Set-up

**GRAPHIC SIZE:**  
33" x 78.75" ( 85cm x 200cm )

**WEIGHT:**  
4.8 LB ( 2.1 Kg )

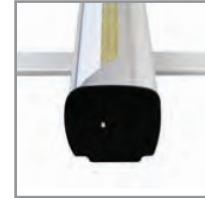

CARRYING BAG

## ROLL-UP ECO 24

- High Volume Application
- Low Pricing Point
- Light Weight
- Perfect Solution for Limited Display Area
- Easy Set-up

**GRAPHIC SIZE:**  
23.25" x 70.75" ( 59cm x 180cm )

**WEIGHT:**  
4 LB ( 1.8 Kg )

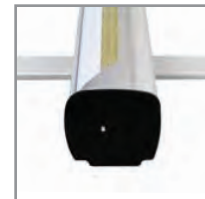

## OPTIONS



**CLAMP LIGHT**  
(Silver)



### CANVAS HARD BAG

Available in 40" & 52"

\* 40" - Inner dimension 39"x10"x3.5"

\* 52" - Inner dimension 51"x11"x3.5"

# ROLL-UP SWAP II

- Lightweight & a breeze to set up
- Easy cartridge replacement system
- New snap type top profile and snap type cartridge (Easy graphic replacement)
- Easy click open cartridge cover (Button type)
- Set up in 30 seconds
- Telescopic center pole

<b>GRAPHIC SIZES:</b>	<b>WEIGHT:</b>
33" x 33"~92" (85cm x 85cm~234cm)	9.8 LB (4.4 Kg)



CARRYING BAG



## OPTIONS



**CLAMP LIGHT**  
(Silver)



### CANVAS HARD BAG

Available in 40" & 52"

\* 40" - Inner dimension 39"x10"x3.5"

\* 52" - Inner dimension 51"x11"x3.5"



CARRYING BAG

## ROLL-UP NUBI

- Premium and tough - made of thick, heavy-duty aluminum
- Great stability • Semi wide base

**GRAPHIC SIZES:**

33" x 78.75" ( 85cm x 200cm )

**WEIGHT:**

9.8 LB ( 4.4 Kg )



### OPTIONS



**CLAMP LIGHT**  
(Silver)



**CANVAS HARD BAG**

Available in 40" & 52"

\* 40" - Inner dimension 39"x10"x3.5"

\* 52" - Inner dimension 51"x11"x3.5"

## ROLL-UP BANNERS COMPARISON CHART

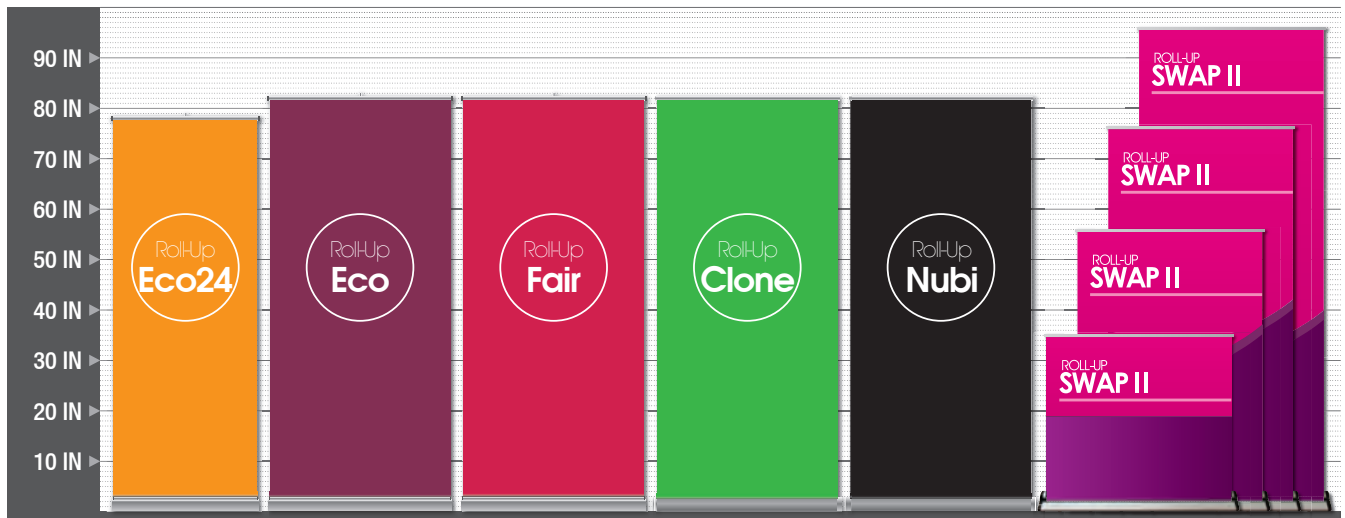



## ROLL-UP SWAP V36

- Light weight & a breeze to set up
- Quick and simple with hook & loop strip leader on bottom
- Snap rail on top
- Wide base
- Set up in 30 seconds
- Telescopic center pole
- Canvas Hard Bag included

**GRAPHIC SIZES:**  
35.5" x 69"~92" (91.5cm x 175~234cm)  
**WEIGHT:**  
14 LB (6.4 Kg)



## ROLL-UP SWAP V48

- Light weight & a breeze to set up
- Quick and simple with hook & loop strip leader on bottom
- Snap rail on top
- Wide base
- Set up in 30 seconds
- Dual telescopic center pole
- 4 ft. wide banner
- Canvas Hard Bag included

**GRAPHIC SIZES:**  
47.5" x 69"~92" (122cm x 175~234cm)  
**WEIGHT:**  
18.4 LB (8.3 Kg)



# ROLL-UP SWAP V60

- Light weight & a breeze to set up
- Quick and simple with hook & loop strip leader on bottom
- Snap rail on top
- Wide base
- Set up in 30 seconds
- Dual telescopic center pole
- 5 ft. wide banner
- Canvas Hard Bag included

**GRAPHIC SIZES:**  
59" x 69"~92" ( 150cm x 175~234cm )

**WEIGHT:**  
23 LB ( 10.4 Kg )

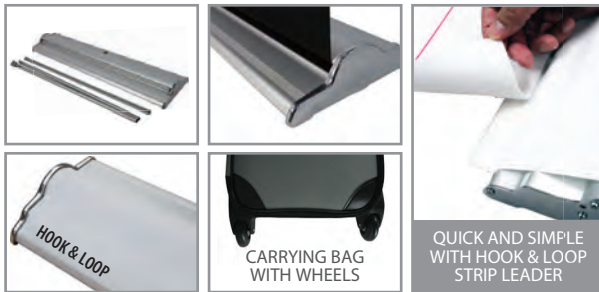

## SWAP V COMPARISON CHART

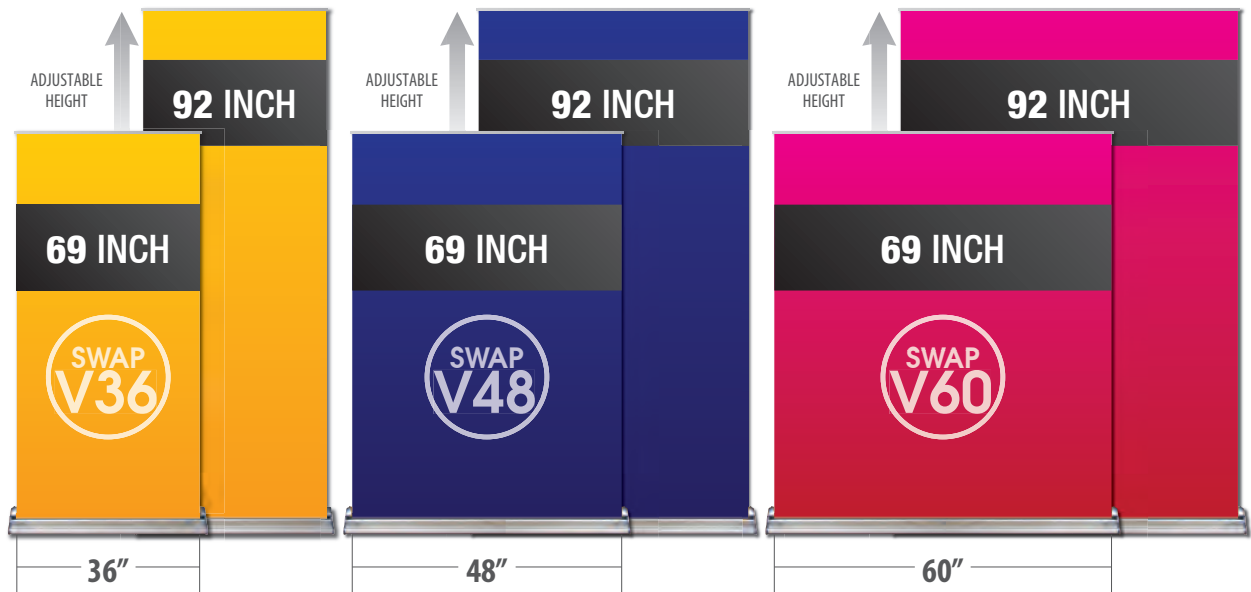

# Fabric Pop Up Systems

Our ultra lightweight aluminum alloy fabric pop up display is an impressive backdrop for your tradeshow, exhibition, or conference. Hi-res printing with dye sublimation on premium quality fabric is fastened on the frame with hook and loop, which means you do not need to attach your image to the product each time you set it up.



- Quick and easy set-up of the fabric display
- The graphic is stretched out as you set up the frame
- Wrinkle resistant premium quality fabric
- Light weight aluminum frame with graphic collapses into a compact unit
- No hassles with bars or magnets
- No panels to fix or roll away
- No worrying about image details matching up on graphic panels
- No tools required



Standard Carrying Bag with trolley for 8', 10' (Canvas Bag for 5', 15', 20' & FP Counter Stand)



## FABRIC POP UP COUNTER STAND

**ITEM:** FP-Counter  
**GRAPHIC SIZE:**  
 W. 69.69" (177cm)  
 H. 37.40" (95cm)  
**WEIGHT:** 22 LB (10 KG)



## FABRIC POP UP TABLE TOP 5FT

**WITH ENDCAPS**  
**ITEM:** F5-2x2S with Endcaps  
**GRAPHIC SIZE:**  
 W. 85.43" (217cm)  
 H. 59.06" (150cm)  
**WEIGHT:** 13 LB (6 KG)



## FABRIC POP UP CURVE 8FT

**WITH ENDCAPS**

**ITEM:** F8-3x3C with Endcaps  
**GRAPHIC SIZE:**  
 W. 107.99" (274.3cm)  
 H. 88.58" (225cm)  
**WEIGHT:** 22 LB (10 KG)



## FABRIC POP UP CURVE 10FT

**WITH ENDCAPS**

**ITEM:** F10-4x3C with Endcaps  
**GRAPHIC SIZE:**  
 W. 134.80" (342.4cm)  
 H. 88.58" (225cm)  
**WEIGHT:** 24 LB (11 KG)



## FABRIC POP UP CURVE 8FT

**WITHOUT ENDCAPS**

**ITEM:** F8-3x3C w/o Endcaps  
**GRAPHIC SIZE:**  
 W. 82.4" (209.3cm)  
 H. 88.58" (225cm)  
**WEIGHT:** 22 LB (10 KG)



## FABRIC POP UP CURVE 10FT

**WITHOUT ENDCAPS**

**ITEM:** F10-4x3C w/o Endcaps  
**GRAPHIC SIZE:**  
 W. 109.21" (277.4cm)  
 H. 88.58" (225cm)  
**WEIGHT:** 24 LB (11 KG)





**FABRIC POP UP STRAIGHT 8FT**

**WITH ENDCAPS**

**ITEM:** F8-3x3S with Endcaps  
**GRAPHIC SIZE:**  
 W. 114.17" (290cm)  
 H. 88.58" (225cm)  
**WEIGHT:** 22 LB (10 KG)



**FABRIC POP UP STRAIGHT 10FT**

**WITH ENDCAPS**

**ITEM:** F10-4x3S with Endcaps  
**GRAPHIC SIZE:**  
 W. 143.7" (365cm)  
 H. 88.58" (225cm)  
**WEIGHT:** 24 LB (11 KG)



**FABRIC POP UP STRAIGHT 8FT**

**WITHOUT ENDCAPS**

**ITEM:** F8-3x3S w/o Endcaps  
**GRAPHIC SIZE:**  
 W. 88.58" (225cm)  
 H. 88.58" (225cm)  
**WEIGHT:** 22 LB (10 KG)



**FABRIC POP UP STRAIGHT 10FT**

**WITHOUT ENDCAPS**

**ITEM:** F10-4x3S w/o Endcaps  
**GRAPHIC SIZE:**  
 W. 118.11" (300cm)  
 H. 88.58" (225cm)  
**WEIGHT:** 24 LB (11 KG)



**FABRIC POP UP STRAIGHT 15FT**

**WITH ENDCAPS**

**ITEM:** F15-6x3S with Endcaps  
**GRAPHIC SIZE:**  
 W. 201.18" (511 cm)  
 H. 88.58" (225 cm)  
**WEIGHT:** 42 LB (19 KG)



**FABRIC POP UP STRAIGHT 20FT**

**WITH ENDCAPS**

**ITEM:** F20-8x3S with Endcaps  
**GRAPHIC SIZE:**  
 W. 259.06" (658cm)  
 H. 88.58" (225cm)  
**WEIGHT:** 53 LB (24 KG)



**FABRIC POP UP STRAIGHT 15FT**

**WITHOUT ENDCAPS**

**ITEM:** F15-6x3S w/o Endcaps  
**GRAPHIC SIZE:**  
 W. 175.58" (446 cm)  
 H. 88.58" (225cm)  
**WEIGHT:** 42 LB (19 KG)



**FABRIC POP UP STRAIGHT 20FT**

**WITHOUT ENDCAPS**

**ITEM:** F20-8x3S w/o Endcaps  
**GRAPHIC SIZE:**  
 W. 233.46" (593cm)  
 H. 88.58" (225cm)  
**WEIGHT:** 53 LB (24 KG)

**OPTIONS**



**HALOGEN LIGHT**

(2pcs/set)  
**WEIGHT:** 3.5 LB (1.6 KG)



**LED LIGHT**

(1pc)  
**WEIGHT:** 2.2 LB (1 KG)

\* 2 pcs of LED lights are required.



**SQUARE HARD CASE**

**WEIGHT:** 13.2 LB (6 KG)  
**DIMENSIONS:**  
 W. 16.5" x D. 15" x H. 39"



**ROUND HARD CASE**

**WEIGHT:** 26.4 LB (12 KG)  
**DIMENSIONS:**  
 W. 27.5" x D. 15.5" x H. 39"



# Tension Fabric Systems

Our fabric wall system offers an uniquely simple and portable way to create a customized backdrop. Built with highly durable and light weight aluminum tubing that is available in many shapes. Snap-on connectors allow for easy set-up and take down. Sewn with a convenient zipper, the wrinkle resistant premium stretch-fabric graphic slips over the frame like a pillowcase for quick set up. This fabric display give a sharp, singular look, and its portability and simple setup ensure a worry-free experience during a trade show or special event. Light kit pack and molded plastic transportation cases with wheels are available. No tools are required.

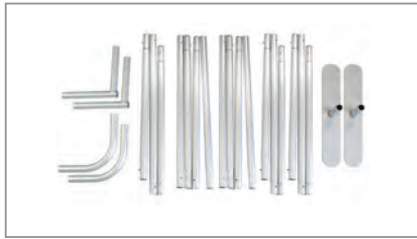

Zip-Up

Custom Square coners available (Flat models only)



Push-Button Connector



Spot Light Connector



Standard Canvas Hard Bag for Wall Systems



## TENSION FABRIC 8FT

FLAT

ITEM: TF-F08  
**GRAPHIC SIZE:**  
 W. 96.06" (244 cm)  
 H. 89.76" (228 cm)  
**WEIGHT:** 18 LB (8 KG)



## TENSION FABRIC 10FT

FLAT

ITEM: TF-F10  
**GRAPHIC SIZE:**  
 W. 114.96" (292 cm)  
 H. 89.76" (228 cm)  
**WEIGHT:** 21 LB (9.5 KG)



## TENSION FABRIC 20FT

FLAT

ITEM: TF-F20  
**GRAPHIC SIZE:**  
 W. 234.84" (596.5 cm)  
 H. 89.76" (228 cm)  
**WEIGHT:** 36 LB (16.3 KG)



## TENSION FABRIC 8FT

HORIZONTAL CURVE

ITEM: TF-HC08  
**GRAPHIC SIZE:**  
 W. 101.18" (257 cm)  
 H. 89.76" (228 cm)  
**WEIGHT:** 21 LB (9.3 KG)



## TENSION FABRIC 10FT

HORIZONTAL CURVE

ITEM: TF-HC10  
**GRAPHIC SIZE:**  
 W. 125.59" (319 cm)  
 H. 89.76" (228 cm)  
**WEIGHT:** 21 LB (9.3 KG)



## TENSION FABRIC 20FT

HORIZONTAL CURVE

ITEM: TF-HC20  
**GRAPHIC SIZE:**  
 W. 243.5" (618.5 cm)  
 H. 89.76" (228 cm)  
**WEIGHT:** 37 LB (17 KG)

\* custom size is available.



\* Lighting options are not available

## TENSION FABRIC 8FT

S SHAPE

ITEM: TF-S08  
 GRAPHIC SIZE:  
 W. 101.18" (257 cm)  
 H. 89.76" (228 cm)  
 WEIGHT: 18 LB (8 KG)



## TENSION FABRIC 10FT

S SHAPE

ITEM: TF-S10  
 GRAPHIC SIZE:  
 W. 127.36" (323.5 cm)  
 H. 89.76" (228 cm)  
 WEIGHT: 22 LB (10 KG)



## TENSION FABRIC 20FT

S SHAPE

ITEM: TF-S20  
 GRAPHIC SIZE:  
 W. 256.69" (652 cm)  
 H. 89.76" (228 cm)  
 WEIGHT: 34 LB (15.5 KG)



\* Compatible with Flat Models only.  
 \* Double Sided

## TENSION FABRIC FLAT HEADER

HEADER

ITEM: TF-HEADER  
 DISPLAY SIZE:  
 32"(W) x 15.75"(H)  
 48"(W) x 15.75"(H)  
 60"(W) x 15.75"(H)



## STRETCH PODIUM HARD CASE

ITEM: TF-STRETCH PODIUM  
 DISPLAY SIZE:  
 W. 21" (53cm) D. 15" (37 cm)  
 H. 38.5" (97.5cm)  
 WEIGHT: 25.2LB (11.4KG)

- Quickly and easily transform into a podium with fabric cover
- Perfect for transporting your Tension Fabric Wall Systems and accessories
- Equipped with wheels for easy transportation



## MONITOR MOUNT & SHELF

DISPLAY SIZE:  
 W. 31" (78cm) D. 15" (38 cm)  
 H. 92" (234cm)  
 WEIGHT: 25LB (11KG)  
 \* Compatible with Flat Models only,  
 Monitor & Tension fabric wall not included

Carrying Bag



## OVERLAP PANEL

DISPLAY SIZE:  
 W. 51" (130cm) D. 18" (46cm)  
 H. 96" (244cm)  
 WEIGHT: 14LB (6KG)  
 \* Compatible with Flat Models only  
 (10ft & 20ft)  
 Tension fabric wall not included

Options

## OPTIONS



**HALOGEN LIGHT**  
 (2pcs/set)  
 WEIGHT: 3.5 LB (1.6 KG)



**LED LIGHT**  
 (1pc)  
 WEIGHT: 2.2 LB (1 KG)



**SQUARE HARD CASE**  
 WEIGHT: 13.2 LB (6 KG)  
 DIMENSIONS:  
 W. 16.5" x D. 15" x H. 39"



**ROUND HARD CASE**  
 WEIGHT: 26.4 LB (12 KG)  
 DIMENSIONS:  
 W. 27.5" x D. 15.5" x H. 39"

\* custom size is available.

# TENSION FABRIC SYSTEM FUSION BOOTH

- Premium quality dye sublimation printing on 100% Polyester fabric material.
- "Ready to Go" Booth solutions.
- Monitors not included in package.



**Fusion 8-01**

**DISPLAY SIZE:**

W. 94.49" x H. 92.7" (W. 240cm x H. 235.4cm)



**Fusion 10-01**

**DISPLAY SIZE:**

W. 118.11" x H. 92.7" (W. 300cm x H. 235.4cm)



**Fusion 10-02**

**DISPLAY SIZE:**

W. 118.11" x H. 92.7" (W. 300cm x H. 235.4cm)



**Fusion 10-03**

**DISPLAY SIZE:**

W. 118.11" x H. 121.1" (W. 300cm x H. 307.6cm)



**Fusion 10-04**

**DISPLAY SIZE:**

W. 118.11" x H. 92.7" (W. 300cm x H. 235.4cm)



**Fusion 10-05**

**DISPLAY SIZE:**

W. 118.11" x H. 94.9" (W. 300cm x H. 241cm)



**Fusion 10-06**

**DISPLAY SIZE:**

W. 118.11" x H. 92.7" (W. 300cm x H. 235.4cm)



**Fusion 10-07**

**DISPLAY SIZE:**

W. 118.11" x H. 92.7" (W. 300cm x H. 235.4cm)



**Fusion 10-08**

**DISPLAY SIZE:**

W. 118.11" x H. 92.7" (W. 300cm x H. 235.4cm)



**Fusion 10-09**

**DISPLAY SIZE:**

W. 118.11" x H. 92.7" (W. 300cm x H. 235.4cm)



**Fusion 10-10**

**DISPLAY SIZE:**

W. 118.11" x H. 92.7" (W. 300cm x H. 235.4cm)



**Fusion 10-11**

**DISPLAY SIZE:**

W. 118.11" x H. 94.9" (W. 300cm x H. 241cm)

*\* custom size is available.*



# TENSION FABRIC SYSTEM FUSION BOOTH

- Premium quality dye sublimation printing on 100% Polyester fabric material.
- "Ready to Go" Booth solutions.
- Monitors not included in package.



## Fusion 10-12

**DISPLAY SIZE:**  
W. 118.11" x H. 83.1" (W. 300cm x H. 211cm)



## Fusion 17-01

**DISPLAY SIZE:**  
W. 196.85" x H. 92.7" (W. 500cm x H. 235.4cm)



## Fusion 18-01

**DISPLAY SIZE:**  
W. 212.6" x H. 92.7" (W. 540cm x H. 235.4cm)



## Fusion 18-02

**DISPLAY SIZE:**  
W. 212.6" x H. 92.7" (W. 540cm x H. 235.4cm)



## Fusion 18-03

**DISPLAY SIZE:**  
W. 212.6" x H. 92.7" (W. 540cm x H. 235.4cm)



## Fusion 18-04

**DISPLAY SIZE:**  
W. 212.6" x H. 92.7" (W. 540cm x H. 235.4cm)



## Fusion 18-05

**DISPLAY SIZE:**  
W. 212.6" x H. 92.7" (W. 540cm x H. 235.4cm)



## Fusion 18-06

**DISPLAY SIZE:**  
W. 212.6" x H. 92.7" (W. 540cm x H. 235.4cm)



## Fusion 18-07

**DISPLAY SIZE:**  
W. 212.6" x H. 92.7" (W. 540cm x H. 235.4cm)



## Fusion 18-08

**DISPLAY SIZE:**  
W. 212.6" x H. 121.1" (W. 540cm x H. 307.6cm)



## Fusion 18-09

**DISPLAY SIZE:**  
W. 212.6" x H. 92.7" (W. 540cm x H. 235.4cm)



## Fusion 18-10

**DISPLAY SIZE:**  
W. 212.6" x H. 92.7" (W. 540cm x H. 235.4cm)

\* custom size is available.



# TENSION FABRIC SYSTEM FUSION BOOTH

- Premium quality dye sublimation printing on 100% Polyester fabric material.
- "Ready to Go" Booth solutions.
- Monitors not included in package.



## Fusion 18-11

DISPLAY SIZE:

W. 212.6" x H. 92.7" (W. 540cm x H. 235.4cm)



## Fusion 19-01

DISPLAY SIZE:

W. 228.35" x H. 121.1" (W. 580cm x H. 307.6cm)



## Fusion 19-02

DISPLAY SIZE:

W. 228.35" x H. 92.7" (W. 580cm x H. 235.4cm)



## Fusion 19-03

DISPLAY SIZE:

W. 228.35" x H. 94.9" (W. 580cm x H. 241cm)



## Fusion 20-01

DISPLAY SIZE:

W. 236.22" x H. 92.7" (W. 600cm x H. 235.4cm)



## Fusion 20-02

DISPLAY SIZE:

W. 236.22" x H. 121.1" (W. 600cm x H. 307.6cm)



## Fusion 20-03

DISPLAY SIZE:

W. 236.22" x H. 92.7" (W. 600cm x H. 235.4cm)



## Fusion 20-04

DISPLAY SIZE:

W. 236.22" x H. 92.7" (W. 600cm x H. 235.4cm)



## Fusion 20-05

DISPLAY SIZE:

W. 236.22" x H. 92.7" (W. 600cm x H. 235.4cm)



## Fusion 20-06

DISPLAY SIZE:

W. 236.22" x H. 92.7" (W. 600cm x H. 235.4cm)



## Fusion 20-07

DISPLAY SIZE:

W. 236.22" x H. 92.7" (W. 600cm x H. 235.4cm)



## Fusion 20-08

DISPLAY SIZE:

W. 236.22" x H. 92.7" (W. 600cm x H. 235.4cm)

\* custom size is available.

# TENSION FABRIC SYSTEM PODIUM/RACK

- Highly Durable and Light weight aluminum tubing
- Snap-on connectors for easy set-up and take down
- Wooden counter top & bottom
- Frosted acrylic shelves for Rack series
- Sewn with a convenient zipper
- Wrinkle resistant premium stretch fabric graphic



## PODIUM TRIANGLE

**DISPLAY SIZE:**    **WEIGHT:**  
W. 23.65" (60cm)    20 LB (9 KG)  
D. 23.65" (60cm)  
H. 40" (102cm)

## RACK TRIANGLE

**DISPLAY SIZE:**    **WEIGHT:**  
W. 23.65" (60cm)    43 LB (19.5 KG)  
D. 23.65" (60cm)  
H. 76" (193cm)



## PODIUM OVAL

**DISPLAY SIZE:**    **WEIGHT:**  
W. 23.45" (60cm)    17.6 LB (8 KG)  
D. 15.55" (40cm)  
H. 40" (102cm)

## RACK OVAL

**DISPLAY SIZE:**    **WEIGHT:**  
W. 23.45" (60cm)    41 LB (18.5 KG)  
D. 15.55" (40cm)  
H. 76" (193cm)



## PODIUM SQUARE

**DISPLAY SIZE:**    **WEIGHT:**  
W. 31.5" (80cm)    30 LB (13.5 KG)  
D. 20.85" (53cm)  
H. 40" (102cm)

## RACK SQUARE

**DISPLAY SIZE:**    **WEIGHT:**  
W. 31.5" (80cm)    53 LB (24 KG)  
D. 20.85" (53cm)  
H. 76" (193cm)



## RACK BACKWALL

**DISPLAY SIZE:**    **WEIGHT:**  
W. 36.5" (93cm)    46 LB (21 KG)  
D. 17.5" (45cm)  
H. 79" (200cm)



# TENSION FABRIC SYSTEM BRAND+ FITTING ROOM

- Portable fitting room with customized graphics
- Highly Durable and Light weight aluminum tubing
- Snap-on connectors for easy set-up and take down
- Sewn with a convenient zipper
- Wrinkle resistant premium stretch fabric graphic

**DISPLAY SIZE:**    **WEIGHT:**  
W. 39" (99cm)    26 LB (12 KG)  
D. 48" (122cm)  
H. 89.5" (227cm)



## TENSION FABRIC SYSTEM TABLET STAND

- Quick set up with aluminum tubing system
- Perfect branding solution
- Pillowcase style wrinkle free stretch fabric graphic with zipper

**DISPLAY SIZE:**  
W. 15" (38 cm)  
H. 54" (137cm)

**WEIGHT:**  
6.8LB (3.1KG)



Carrying Bag



## TENSION FABRIC SYSTEM EASY-TUBE

- Quick set up with aluminum tubing system
- Sturdy steel base
- Perfect solution for limited display space
- Pillowcase style wrinkle free stretch fabric graphic with zipper

**DISPLAY SIZE:**  
W. 36" (91cm)  
D. 10" (25cm)  
H. 90" (229cm)

**WEIGHT:**  
21LB (9.5KG)



Carrying Bag



## TENSION FABRIC SYSTEM BAAM

Uniquely shaped freestanding structure that delivers your brand or presentation message with innovative style.

- Highly Durable and Light weight
- Easy 5 minute assembly.
- 7.5' height – 3' width Frame Structures.
- Sewn with a convenient zipper
- Wrinkle resistant premium stretch-fabric graphic
- No tools required

### BAAM ▶

**DISPLAY SIZE:**  
W. 36" (91cm)  
H. 90" (229cm)  
**WEIGHT:**  
17.6 LB (8 KG)



### ◀ BAAM2

**DISPLAY SIZE:**  
W. 36" (91cm)  
H. 90" (229cm)  
**WEIGHT:**  
17.6 LB (8 KG)



Carrying Bag

### PYLON ▶

**GRAPHIC SIZE:**  
W. 34.65" (88cm)  
H. 79.92" (203cm)  
**WEIGHT:**  
17.6 LB (8 KG)



Carrying Bag



## TENSION FABRIC SYSTEM PYLON

- Simple and portable solution for banner stand
- Highly Durable and Light weight aluminum tubing
- Snap-on connectors for easy set-up and take down
- Sewn with a convenient zipper
- Wrinkle resistant premium stretch-fabric graphic
- No tools required

### ◀ PYLON2

**GRAPHIC SIZE:**  
W. 32.68" (83cm)  
H. 81.89" (208cm)  
**WEIGHT:**  
17.6 LB (8 KG)



Carrying Bag





## TENSION FABRIC SYSTEM **LUNAR**

- Highly Durable and Light weight aluminum tubing
- Snap-on connectors for easy set-up and take down
- Sewn with a convenient zipper
- Wrinkle resistant premium stretch-fabric graphic
- No tools required

**GRAPHIC SIZE:**  
W. 263.8" (670cm)  
H. 89.4" (227cm)

**WEIGHT:**  
36 LB (16.5 KG)



Standard Carrying Bag

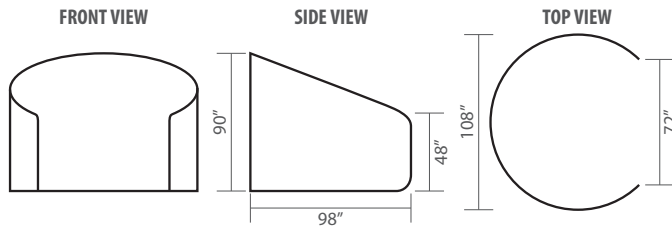
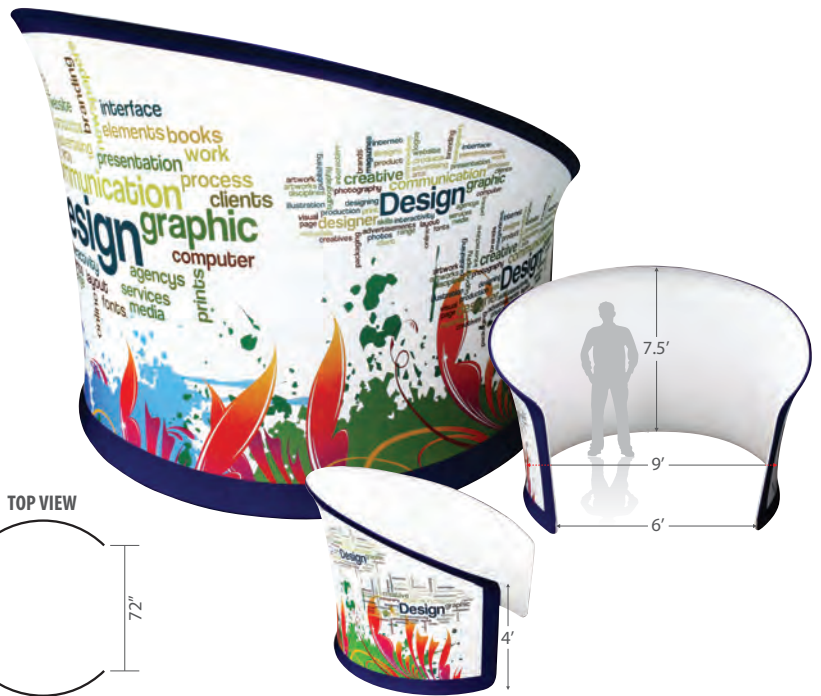

Column Rectangle

Column Square

## TENSION FABRIC SYSTEM **COLUMN**

- Utilize all four sides for maximum exposure
- Quick set up with aluminum tubing system
- Pillowcase style wrinkle free stretch fabric graphic with zipper



Standard Carrying Bag

### COLUMN RECTANGLE

**DISPLAY SIZE:**  
W. 20" (50cm)  
H. 79" (200cm)  
D. 28" (70cm)

**WEIGHT:**  
13.5LB (6KG)

### COLUMN SQUARE

**DISPLAY SIZE:**  
W. 31.5" (80cm)  
H. 118" (300cm)  
D. 31.5" (80cm)

**WEIGHT:**  
17.5LB (8KG)

## TENSION FABRIC SYSTEM **ARC**

- Highly Durable and Light weight aluminum tubing
- Snap-on connectors for easy set-up and take down
- Sewn with a convenient zipper
- Wrinkle resistant premium stretch-fabric graphic
- No tools required

**DISPLAY SIZE:**  
W. 98" (250cm)  
H. 87" (220cm)  
D. 16" (40cm)

**WEIGHT:**  
25.8LB (11.7KG)



Standard Carrying Bag





# TENSION FABRIC SYSTEM ARCH DISPLAYS

- Highly durable and lightweight aluminum tubing system
- Unique and stunning entryway that will stand out from the crowd
- Pillowcase style wrinkle free stretch fabric graphic with zipper
- No tools required



Standard Canvas Hard Bag with wheels for all ARCH models

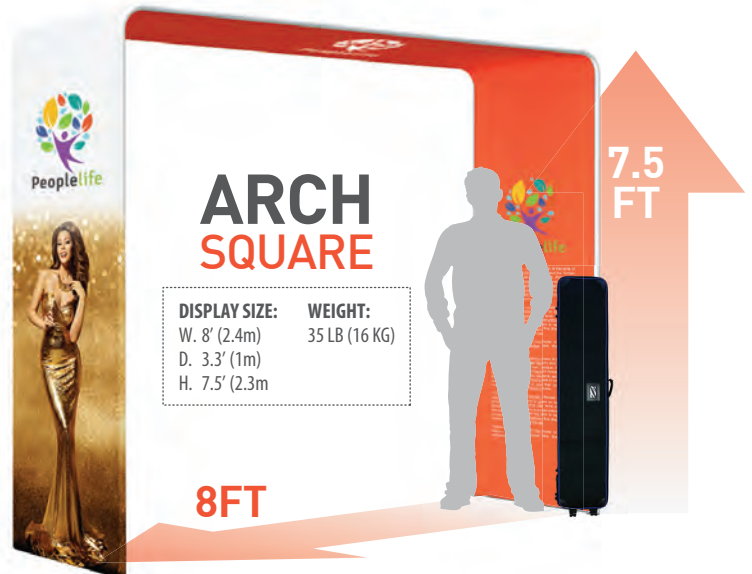
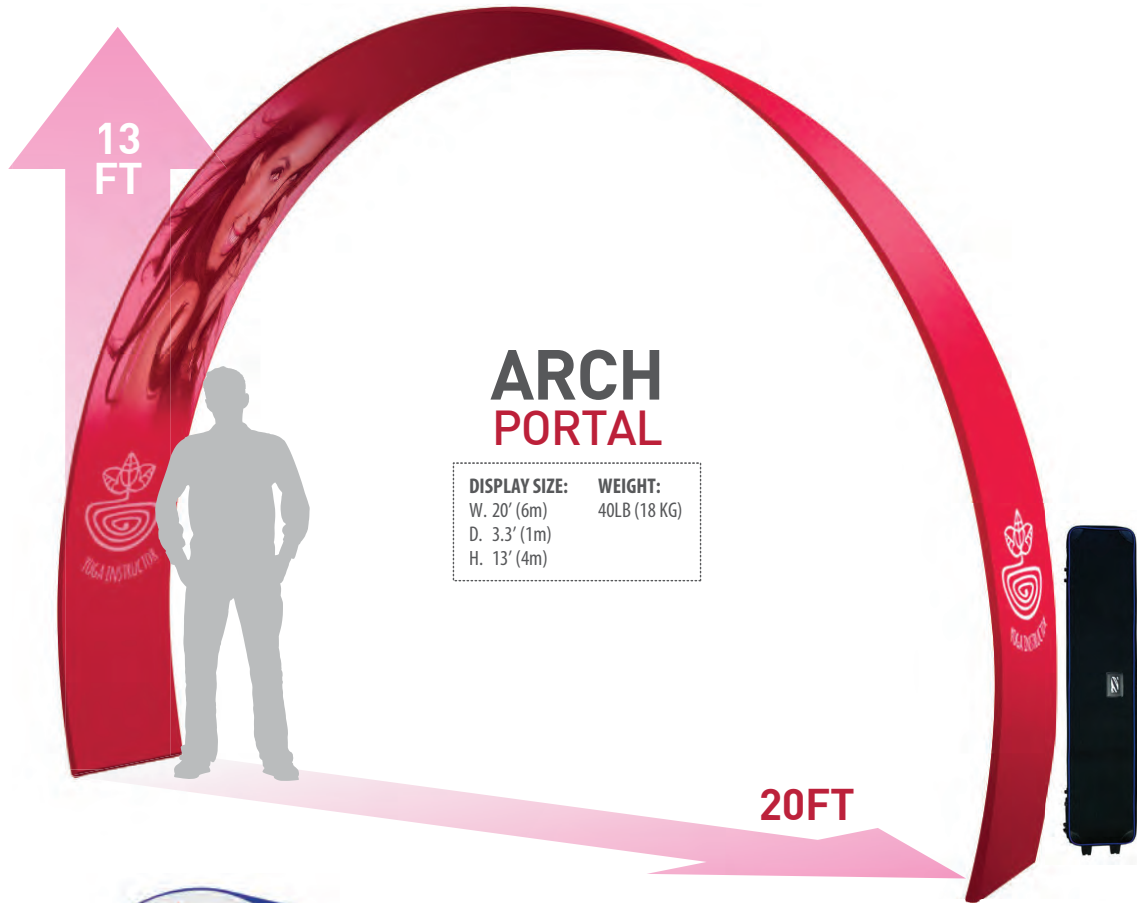

# TENSION FABRIC SYSTEM HANGING BANNERS

- Get noticed from a distance with hanging signs above your booth
- Varieties of unique shapes and sizes available
- Highly durable and lightweight aluminum tubing system
- Pillowcase style wrinkle free stretch fabric graphic with zipper

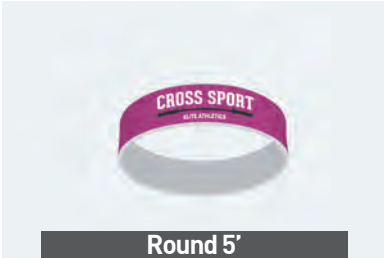

Round 5'



Round 10'



Round 20'



Funnel



Halo



Leaf



Rectangle



Square



Triangle



Triangle-Curve



Cyclone



Circle-H



Cube-A



Cube-B



Circle-V

# Table Throws & Covers

• Full color dye sublimation printing on fabric

• Machine washable

• Fire Retardant

## NON-FITTED TABLE THROW



<b>4FT</b>	<b>6FT</b>	<b>8FT</b>
WEIGHT: 3.5 LB (1.5 KG)	WEIGHT: 3.5 LB (1.5 KG)	WEIGHT: 3.5 LB (1.5 KG)

### OPTIONS



## FITTED TABLE THROW



<b>4FT</b>	<b>6FT</b>	<b>8FT</b>
WEIGHT: 3.5 LB (1.5 KG)	WEIGHT: 3.5 LB (1.5 KG)	WEIGHT: 3.5 LB (1.5 KG)

### OPTIONS



## STRETCH TABLE THROW



<b>4FT</b>	<b>6FT</b>	<b>8FT</b>
WEIGHT: 2.2LB (1KG)	WEIGHT: 3.5 LB (1.5 KG)	WEIGHT: 3.5 LB (1.5 KG)

### OPTIONS



## CONVERTIBLE TABLE THROW



(8' Table throw transforms into a 6' Table throw)

<b>8FT to 6FT</b>
WEIGHT: 5.5LB (2.5KG)

### OPTIONS

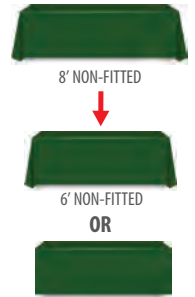

## TABLE RUNNER



### OPTIONS



<b>W.24in x H.88in</b>	<b>W.30in x H.88in</b>	<b>W.60in x H.88in</b>
WEIGHT: 1.1LB (0.5KG)	WEIGHT: 1.1LB (0.5KG)	WEIGHT: 2.2LB (1KG)

### TABLE SIZE:

4' TABLE: W.48" x D.24" x H.29" / 6' TABLE: W.72" x D.30" x H.29" / 8' TABLE: W.96" x D.30" x H.29"  
\* custom size is available.

## TABLE TOPPER



**4FT**

WEIGHT:  
2.2LB (1KG)

**6FT**

WEIGHT:  
2.2LB (1KG)

**8FT**

WEIGHT:  
3.5LB (1.5KG)

## COCKTAIL TABLE COVER



**D.31.5in x H.29in**

WEIGHT:  
2.2LB (1KG)

**D.31.5in x H.43in**

WEIGHT:  
3.5LB (1.5KG)

## CROSS OVER TABLE THROW



**6FT**

WEIGHT:  
4.5LB (2KG)

**8FT**

WEIGHT:  
4.5LB (2KG)

# Table Top Banner

- Grab attention and maximize your space
- Converts to fit both 6' and 8' table
- Wrinkle free premium stretch fabric graphic
- 3 banner styles available (Header, Half wall, Full wall)
- No tools required



Table Top Banner Full



Table Top Banner Half



Table Top Banner Header

**TABLE SIZE:**  
6' TABLE: W.72" x D.30" x H.29" / 8' TABLE: W.96" x D.30" x H.29"



Easy Clamp System



Carrying Bag



# Outdoor Displays

Water Base displays are constructed of high quality aluminum that offer an easy to use attractive, portable and weather proof. It takes simply seconds to change out the graphic.



## SNAP FRAME POSTER STAND

- Molded plastic base with wheels
- Excellent stability
- Easy graphic replacement

SCREEN SIZES:	WEIGHT:	WATER CAPACITY:
23" x 32 3/4" ( 58.42cm x 83.19cm )	35.2 LB ( 16 kg )	56LB (25.5KG)

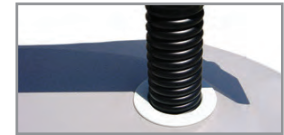

Spring Shocks



Wheels



## AD BASE

- Economical solution
- Easy graphic replacement
- Perfect with Double side prints
- Portable water base with handle

GRAPHIC SIZES:	WEIGHT:	WATER CAPACITY:
24" x 36" ( 60.96cm x 91.44cm )	5.5 LB ( 2.5 kg )	25LB (11KG)



\* Recommended Banner Thickness 4mm

# Literature Stand



- Luxurious brushed aluminum highlights
- Sturdy construction of aluminum frame and travel case
- Up to six slots of acrylic trays
- Perfect solution for displaying literatures and other promotional materials

STAND WEIGHT: 16.5 LB ( 7.5 Kg )

# Pop Out Displays

Pop-Out Banners provide many alternatives to traditional ground-mounted signage. Any message, logo or design can be magically presented to an audience. While erect, they stand bold and informative, but once compacted, these lightweight banners are ideally sized for storage or transporting.

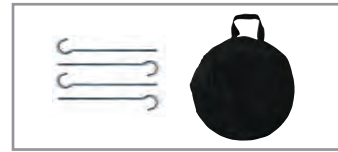

Standard carrying bag with stakes



## HORIZONTAL POP-OUT BANNER

**FABRIC:** Polyester  
**PRINTING METHOD:** UV Treated Dye Sublimation  
**INCLUDES:** Frames with Graphic, Stakes & Carry Bag

Small	GRAPHIC SIZE:	Med	GRAPHIC SIZE:	Large	GRAPHIC SIZE:
	W. 47.24" (120cm) H. 27.56" (70cm)		W. 78.74" (200cm) H. 39.37" (100cm)		W. 102.36" (260cm) H. 43.31" (110cm)



## VERTICAL POP-OUT BANNER

**FABRIC:** Polyester  
**PRINTING METHOD:** UV Treated Dye Sublimation  
**INCLUDES:** Frames with Graphic, Stakes & Carry Bag

Small	GRAPHIC SIZE:	Med	GRAPHIC SIZE:	Large	GRAPHIC SIZE:
	W. 23.62" (60cm) H. 35.43" (90cm)		W. 39.37" (100cm) H. 68.90" (175cm)		W. 47.24" (120cm) H. 84.92" (215.7cm)



## TRIANGLE POP-OUT BANNER

**FABRIC:** Polyester  
**PRINTING METHOD:** UV Treated Dye Sublimation  
**INCLUDES:** Frames with Graphic, Stakes & Carry Bag

Med	GRAPHIC SIZE:	Large	GRAPHIC SIZE:
	W. 47.24" (120cm) H. 48.03" (122cm)		W. 57.09" (145cm) H. 58.07" (147.5cm)



## TOWER POP-OUT BANNER

**FABRIC:** Polyester  
**PRINTING METHOD:** UV Treated Dye Sublimation  
**INCLUDES:** Frames with Graphic, Stakes & Carry Bag

Med	GRAPHIC SIZE:	Large	GRAPHIC SIZE:
	W. 39.37" (100cm) H. 78.74" (200cm)		W. 43.31" (110cm) H. 86.61" (220cm)



## ROUND POP-OUT BANNER

**FABRIC:** Polyester  
**PRINTING METHOD:** UV Treated Dye Sublimation  
**INCLUDES:** Frames with Graphic

Small	GRAPHIC SIZE:	Med	GRAPHIC SIZE:	Large	GRAPHIC SIZE:
	DIAMETER: 39.37" (100cm)		DIAMETER: 47.24" (120cm)		DIAMETER: 59.06" (150cm)

# Flag Banner Systems

The Teardrop / Feather Flag is an innovative flying banner that is truly element defying. Its design ensures that the high impact branded message is always visible. Teardrop / Feather Banners have various mounting options for use in any location or condition, both indoors or outdoors. Guaranteed to use only premium fabric and Fiberglass poles.

## TEARDROP FLAG



### AVAILABLE SIZES:

8', 10' & 14'

### PRINTING METHOD:

UV Treated Dye Sublimation

### IMPRINT LOCATIONS:

Single or Double Sided

### INCLUDES:

Fiberglass Poles, Ground Stake & Padded Carry Bag

### FABRIC:

Polyester

### Includes



Ground Stake



Carrying Bag

### Options



Cross Base



Car Tire Base



Metal Plate (7kg/15lb)



## FEATHER FLAG



### AVAILABLE SIZES:

9', 12' & 16'

### PRINTING METHOD:

UV Treated Dye Sublimation

### IMPRINT LOCATIONS:

Single or Double Sided

### INCLUDES:

Fiberglass Poles, Ground Stake & Padded Carry Bag

### FABRIC:

Polyester

### Includes



Ground Stake



Carrying Bag

### Options



Cross Base



Car Tire Base



Metal Plate (7kg/15lb)



# DURA FLAG



The Dura Flag is an uniquely shaped branding banner, offering single or double sided dye-sublimated graphics. The graphic is always visible from any viewpoint. Available in three sizes, and with various mounting options, these banners offer incredible flexibility in placement and ease of use.

<b>AVAILABLE SIZES:</b> 7', 10' & 14'	<b>PRINTING METHOD:</b> UV Treated Dye Sublimation	<b>FABRIC:</b> Polyester
<b>IMPRINT LOCATIONS:</b> Single or Double Sided	<b>INCLUDES:</b> Fiberglass Poles, Ground Stake & Padded Carry Bag	

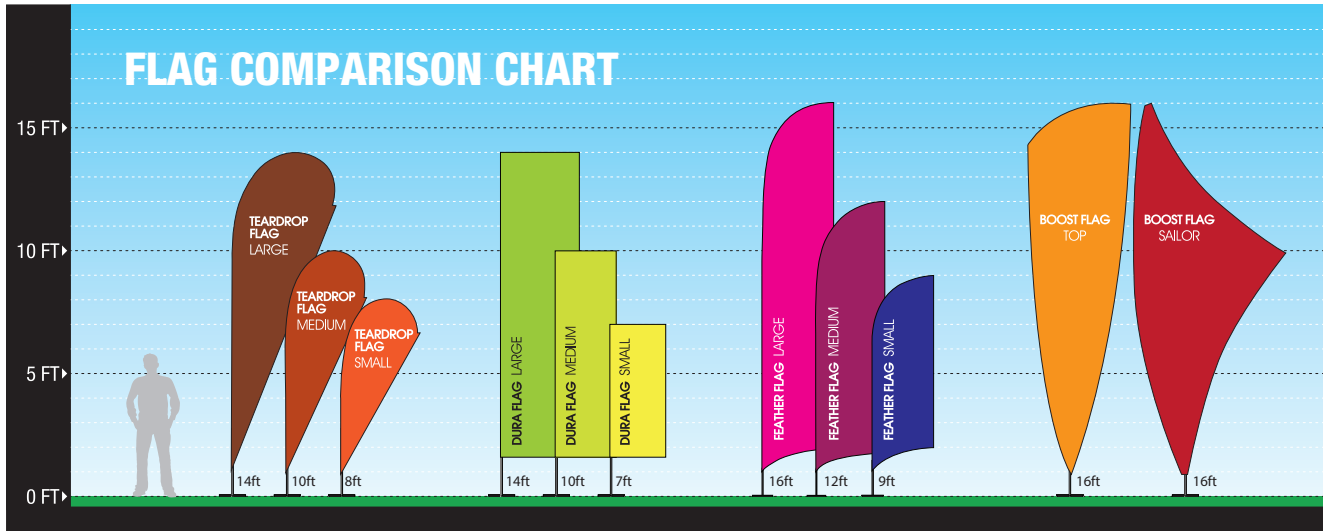
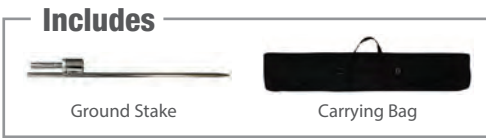

TEARDROP FLAG (Graphic Size)	LARGE	MEDIUM	SMALL
	W. 41.75" x H. 136.64"	W. 40.86" x H. 98.68"	W. 29.13" x H. 68.50"
FEATHER FLAG (Graphic Size)	LARGE	MEDIUM	SMALL
	W. 30.67" x H. 157.88"	W. 29.53" x H. 116.41"	W. 24.80" x H. 78.74"

DURA FLAG (Graphic Size)	LARGE	MEDIUM	SMALL
	W. 29.13" x H. 141.7"	W. 29.13" x H. 100.12"	W. 29.13" x H. 62"
BOOST FLAG (Graphic Size)	SAILOR	TOP	
	W.64.01" x H.154.62"	W.41.57" x H.149.21"	



### SINGLE SIDED

Image is printed on 1 side of the banner for single sided display. The back side shows the see-through mirror image of the front side. (90% Transparency)



### DOUBLE SIDED

Two single sided banners are sewn back to back enabling a double sided display. A block out material is sewn in between the banners to prevent light from shining through.



# BOOST SAILOR 16FT

## TRADESHOW TRAFFIC BOOSTER!

- Designed for indoor use only
- Massive 16 ft. tall flags

<b>STAND SIZE:</b> 16' (480cm)	<b>PRINTING METHOD:</b> UV Treated Dye Sublimation
<b>GRAPHIC SIZE:</b> 4' x 15' (120cm x 450cm)	<b>INCLUDES:</b> Poles, Canvas carry bag, Base plate
<b>IMPRINT LOCATIONS:</b> Single or Double Sided	



Carrying Bag



**INCLUDES:**  
1 steel base

**OUTER CARTON SIZE:**  
22" x 22" x 3.5" (55cm x 55cm x 8cm)

**GROSS WEIGHT:**  
16 LB (7.3 KG)

Base Plate



Base Plate Carrying Bag



# BOOST TOP 16FT

## TRADESHOW TRAFFIC BOOSTER!

- Designed for indoor use only
- Massive 16 ft. tall flags

<b>STAND SIZE:</b> 16' (480cm)	<b>PRINTING METHOD:</b> UV Treated Dye Sublimation
<b>GRAPHIC SIZE:</b> 4' x 15' (120cm x 450cm)	<b>INCLUDES:</b> Poles, Canvas carry bag, Base plate
<b>IMPRINT LOCATIONS:</b> Single or Double Sided	



Carrying Bag



**INCLUDES:**  
1 steel base

**OUTER CARTON SIZE:**  
22" x 22" x 3.5" (55cm x 55cm x 8cm)

**GROSS WEIGHT:**  
16 LB (7.3 KG)

Base Plate



Base Plate Carrying Bag



# Tabletop & Ceiling Displays

Table top & ceiling displays offer instant eye-catching signage that can wonderfully deliver three different messages with one single unit. The ceiling unit can be simply attached on the ceiling and gives random revolving motion via airflow in the room. Newly introducing easy type T-Table Top. No needs of finishing. It's a true space saving table top display. Also our Mini X comes as economical promotional message solution.



## MINI ROLL-UP

- Professionally display even the smallest messages
- Lightweight and very portable
- Ideal choice for complementing point of sale arrangements
- Best suited for long term viewing

### SCREEN SIZE:

A4: W. 8.3"(21.1cm) x H. 11.7"(29.7cm)

A3: W. 11.7"(29.7cm) x H. 16.5"(42cm)



Parts

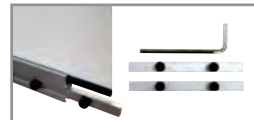

Optional Connector

## CEILING POSTER HANGER

### INCLUDES:

Top & bottom aluminum profiles, rubber strips with double sided tape, plastic hangers and end caps

### SCREEN SIZE:

W. 39.37" (100cm)

## T-TABLE TOP

Small Large

- Truly space saving table top display
- Height adjusting telescopic center pole
- Easy clip type
- No finishing necessary

### SCREEN SIZE:

Small: W. 8" ~ 20" x H. up to 24"  
(W. 20 ~ 50cm x H. up to 60cm)

Large: W. 8" ~ 30" x H. up to 36"  
(W. 20 ~ 75cm x H. up to 90cm)



## MINI X

Small Med Large

- Appropriate for use with full-color graphics
- Ideal for complementing point-of-sale areas
- Pivoting tension poles for simple assembly & disassembly

### SCREEN SIZE:

Small : 6" x 12" (15cm x 30cm)  
Med : 7" x 16.5" (18cm x 42cm)  
Large : 11" x 19" (28cm x 48cm)



# Canopy Systems

Our commercial grade canopy system provides an excellent solution for any outdoor and indoor events. The hexagon shaped extruded aluminum frame is engineered to its perfection allowing the frame to be portable and sturdy at the same time. Full customizable tent top is printed on commercial grade UV treated fabric (resistant to water and fire). This is the perfect solutions for trade show exhibits, sporting events, company events, special promotions and more. No tools required for set up.



- Canopy set includes hexagonal aluminium frame, full color dye sublimation top graphic, canopy ropes & stakes (set of 4) and carrying bag with wheels.
- Light weight hexagon shaped commercial grade aluminum frames (will not corrode in salt water environments).
- Premium quality full color dye sublimation printing on polyester fabric.
- Commercial grade fabric material - fire retardant, water resistant and UV coated.





## ◀ ALUMINUM CANOPY SET

**INCLUDE:**  
Hexagonal aluminium frame, Full color dye sublimation Canopy top, Canopy ropes & stakes, Carrying bag with wheels

### FULL COLOR DYE SUBLIMATION GRAPHICS

ITEM	DESCRIPTION
Canopy top	Printed Canopy top
Full-wall	Full-size printed side wall
Half-wall	Half-size printed side wall



Dura Feather Teardrop Flag Connector Sand Bag

## PARTS & ACCESSORIES

ITEM	DESCRIPTION
Sand Bag	Sand bags (set of 4)
Flag Connector	Flag connector
Teardrop Flag	Single or Double sided
Feather Flag	Single or Double sided
Dura Flag	Single or Double sided

\* TEARDROP/FEATHER/DURA small flag options are available  
– see Flag Banner Systems page for details

\* One sand bag holds up to 20 KG (44 lbs)  
– Sand bags (Set of 4) : 80 KG (176.4 lbs)





# Grande Frameless Fabric Displays

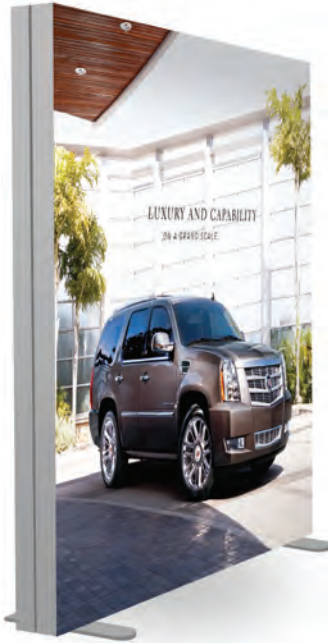

- Appropriate for single or double sided graphic applications
- Premium dye-sublimation printed stretch fabric tucks into the frame for a clean finish
- Features an outlet hole for back-lit presentation using LED light bars
- Frame thickness of 4.75 inch



4 FEET X 8 FEET



8 FEET X 8 FEET



16 FEET X 8 FEET



## OPTIONS



### MEGA CASE

**OUTER DIMENSIONS:** L. 52" x W. 20" x H. 17" (132 cm x 50 cm x 43 cm)

**INNER DIMENSIONS:** L. 51" x W. 19" x H. 13" (130 cm x 47 cm x 32 cm)

**WEIGHT (CASE ONLY):** 35 LB (16 KG)

\* Heavy duty hard case with wheels (optional promo counter set is available)

flyers  
folders  
booklets  
postcards  
brochures  
letterheads  
business cards

# printstuff.ca

BIG OR SMALL, WE PRINT IT ALL.

outdoor banners  
window decals  
backdrops  
posters  
signs  
flags  
tents

## Contact

**Web:** [www.printstuff.ca](http://www.printstuff.ca)  
**Email:** [info@printstuff.ca](mailto:info@printstuff.ca)  
**Phone:** +1 (437) 882-8822

**Head Office:**  
100 King Street West, Suite 5700  
Toronto ON, Canada  
M5X 1A9